



CATALOGUE

German Window & Door Technology

System Solutions to Challenges



Creates Inner Values



INDEX

CONTENTS	PAGE
Roto Frank Holding AG	3
Roto worldwide	4
German made	6
Roto Frank Asian - Pacific	7
Roto Vietnam Representative Office	8
System training center	10
System Solution	11
System overview	12
Roto ITC	14
Certificates	15
Roto Patio Inowa	18
Roto Patio Lift&Slide	22
Roto Patio Alversa	25
Roto Patio Fold&Slide	26
Inward/Outward opening door	29
Sliding door	30
Tilt&Turn Inward opening window	31
Outward opening window	32
Roto X-drive	33
Window Wall	34
Surface treatment	35
Projects references	37
Roto-i Test Results	39

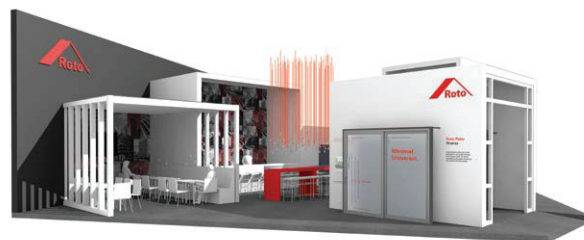

ROTO FRANK HOLDING AG

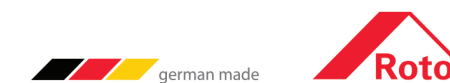

As an established traditional corporation with a broad portfolio of services, Roto constantly adjusts all of its business activities to meet the changing needs of our customers

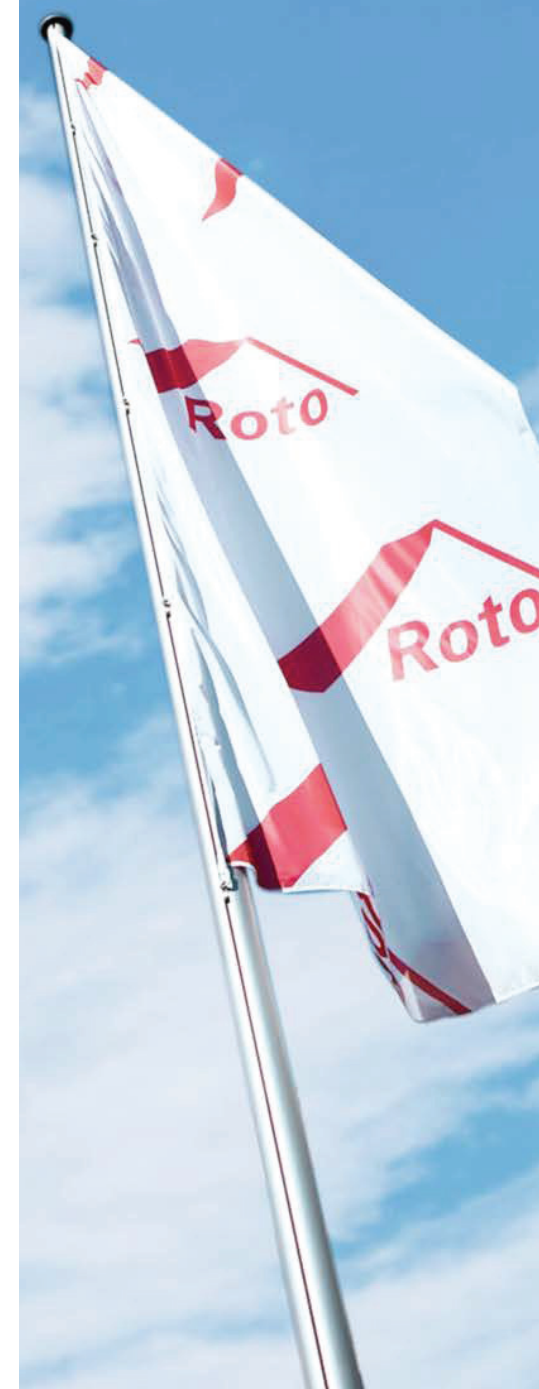

1 SUPERIOR TECHNOLOGY – IMPROVED COMFORT

People around the world put their trust in us because we are the industry leader. They know that we will provide them with individual, efficient and safe system solutions and comprehensive services

2 OUR FUTURE HAS AN ORIGIN

Since 1935, the name Roto represents innovation and technological progress in system components for the construction industry. Today, Roto takes pride in its presence in over 30 countries with more than 5,000 employees, operating in three main sectors including **(1)** Window and Door Technology, **(2)** Roof Windows and Stairs, and **(3)** Consultancy Services. Roto continues its mission to deliver products and services with German branding and quality worldwide

3 SPECIALISTS IN THE MARKETS

Roto Group consistently focuses on expertise and to provide diversified service portfolios from specialised business divisions to meet the challenges of our day.

Our comprehensive product range has been present on enormous buildings, through windows, doors, curtainwall and other elements, and providing excellent functionality, flexibility and reliability to millions of families and end - users with satisfaction and improved living quality

4 ESPECIALLY VALUABLE - AUTHENTICITY

The values shared by both Roto divisions create an authentic corporate identity which has enabled our Group to become the industry leader.

No matter which Roto division you deal with as a customer, you will always benefit from added value. It is this added value that forms the ideal foundation for the success of your cooperation with Roto.

5 YOUR NEEDS ARE OUR INCENTIVE

Based on our principle of market leadership, we strive to consolidate and extend the success of Roto continuously in every market with endless effort from our professional and dynamic team worldwide.

The customers' needs and expectations inspire us at all times.

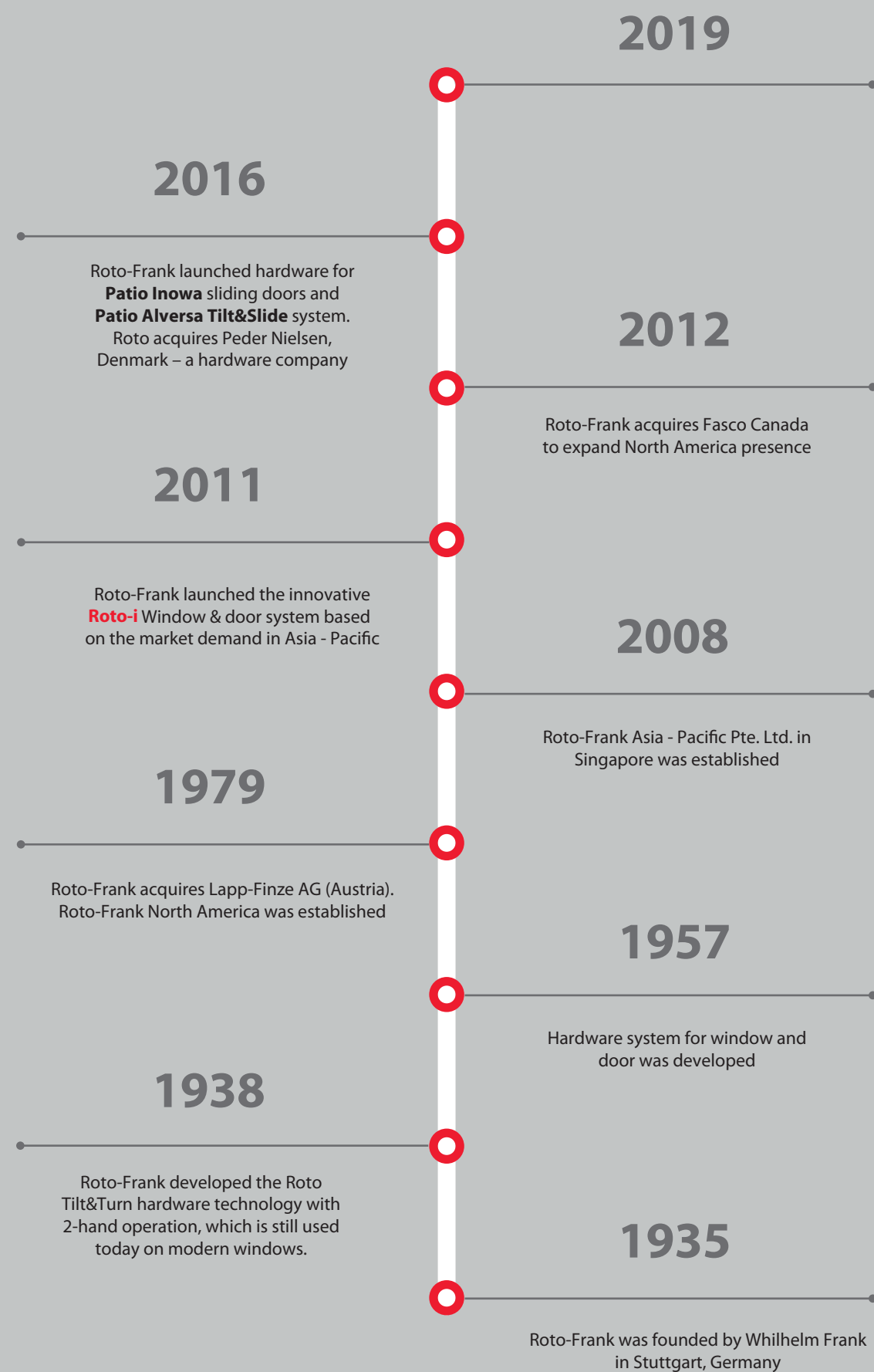

ROTO WORLDWIDE: OUR NAME HAS A JOURNEY

 **18** production sites

 **28** logistics and distribution centers

 **41** sales subsidiaries

 **3500** patents

 **#1** world-leader of Window & Door hardware

GERMAN MADE

German Quality Standards



GERMAN QUALITY STANDARDS THAT YOU CAN COUNT ON

We are the technological leader for our industry. Our on-going success is often attributed to our down-to-earth approach, realism, continuity, consistency and reliability. We believe that this is an encouraging and compelling endorsement of our commitment.

We guarantee that in the services and products associated with the Roto name, you will find German quality standards, regardless of where you are in the world when you deal with Roto.

CLOSE TO THE CUSTOMER CREATES ADDED VALUE

Each country is unique. Professional expertise and an extensive intercultural understanding of the history and customs of people in different countries are vital to understanding the needs of our customers around the world.

However, we do not merely seek to understand, we strive to become valued partners. Roto teams in every country always work closely with the customer and are engaged with, understand and are interested in the specific challenges of a given market.

UNDERSTAND MORE - ACHIEVE MORE

We believe that the key to shared success is based on working together with trust.

That is why we pay close attention to what our customers and employees have to say. We are proactive and plan ahead. We always discuss matters with our partners openly and as equals.

After all, one of our primary objectives is to be the best possible partner for everyone who wants to work with or for Roto.



ROTO FRANK ASIA - PACIFIC

Pioneer and Market Leader in the Asian fenestration industry with more than 30 years of market presence.

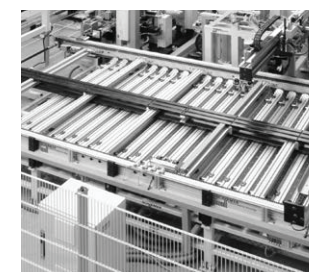

Roto entered the Asian market in the 1990s and brought the German window and door technology to China, Japan, South Korea and Southeast Asia.

After over 20 years of market presence, Roto Frank has not only created an excellent marketing team in Asia, but also built up a professional technical team to provide extensive support, one of the main reasons why so many companies choose Roto as their partner.

In 2008 Roto Frank Asia Pacific Pte. Ltd. in Singapore was established to be able to meet the growing demand in the Asia Pacific region. Customers from Mongolia to New Zealand, South Korea to Sri Lanka and everywhere in between are looked after by the Sales and Technical Team in Singapore.

Roto hardware for windows & doors provides perfect product solutions adaptable to many different profiles and opening types. Based on the high quality manufacturing process and the premium materials used Roto provides a 10 years functional warranty on its hardware.

Roto is a highly regarded solution provider within the industry of European technology for Aluminum, PVC, Timber and Alu-Timber windows, doors and curtain walls in Asia.

Based on its decades of knowledge in the window and door industry Roto launched the innovative Roto window & door system in 2011. The design of the system is based on the market demand in Asia-Pacific. It is engineered according to highest German manufacturing principles while keeping the regional climatic challenges and local application preferences in mind.

Roto has been the preferred choice of numerous projects and has become a successful and reliable high level window & door system



ROTO VIETNAM REPRESENTATIVE OFFICE & SHOWROOM



Roto Frank has been present in the Vietnamese market since 1998, and representative office was established in 2010, with the goal of expanding its market presence in one of the fastest-growing regions in Southeast Asia.

CONTACT INFORMATION:



C9 Mandarin Garden, Hoang Minh Giam, Cau Giay, Hanoi



<https://roto-frank.com.vn/>



Authorized dealer of Roto i. Viet. am:

Econtec VN Design and Investment Joint stock company
23 Tran Kim Xuyen, Yen Hoa, Cau Giay, Hanoi



OUR SERVICES

Close to the customers

Roto offers services throughout the entire life cycle of windows and doors. This involves repairs, maintenance and servicing as an essential part of preserving the value of properties. Roto strives to be a responsible companion of our partners. For each project, our services are carefully performed in a coherent process, ensuring accuracy and efficiency.



Conduct basic research about project, review technical design, study the location and customers' requirements.



Propose optimal solutions to ensure technical standards, functional flexibility, and cost efficiency.



Worldwide delivery service with careful packaging process.



After sales service: periodic maintenance, repair and replacement upon request.



SYSTEM TRAINING CENTER

In order to provide our customers with the best possible service and to extend in-depth technical training in a fabrication environment, Roto has established training centers in Shanghai (2012) and Singapore (2016).

The centers show the complete production process of aluminium windows and doors such as: profile cutting, punching, end - milling, crimping, gluing and the installation of hardware accessory, in order to build a standard platform for high quality German window & door systems.

The main functions of the training centers are:

- 1 To provide technical training on the Rotoi system for business partners to enable them to understand the concept of the system design, system software and system technical drawings.
- 2 To implement training for workers of business partners, to ensure that they can master the system processing and to teach the key points of each production step.
- 3 To support our R & D department.
- 4 To act as a show platform for the system



*System training center

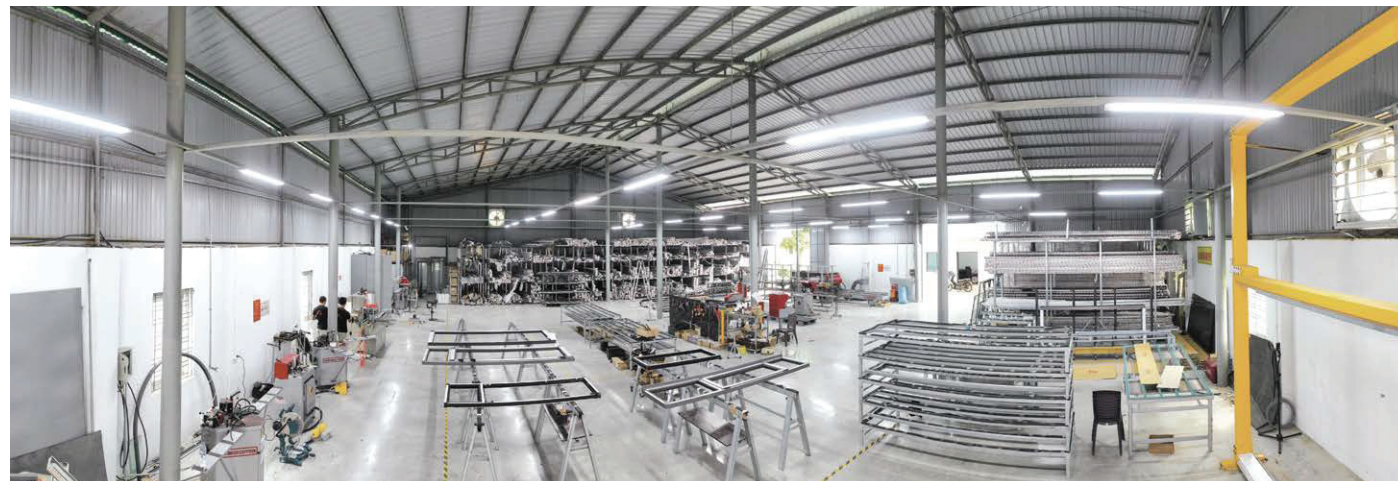





*System training center in Vietnam

SYSTEM SOLUTION

We started as a pioneer in the door accessories industry. Roto has gradually developed products with a focus on providing integrated solutions for windows, doors, and partitions. Our goal is to optimize the customer's product experience by offering a diverse range of product systems (windows, doors, partitions) tailored to different types and markets. These products are designed, manufactured, and tested according to Roto's standards in Europe.



 <h3>QUALITY CONTROL MANAGEMENT</h3> <p>Consistency in production quality management, synchronization in color, design, and technical specifications</p>	 <h3>FUNCTIONAL OPTIMIZATION</h3> <p>Optimizing the operational functionality of each product when used in combination within the system</p>
 <h3>COST EFFICIENCY</h3> <p>Effective investment in time and cost</p>	 <h3>MAINTENANCE EASE</h3> <p>Convenient in maintenance and upkeep during usage</p>

ADVANTAGES OF AN INTEGRATED SYSTEM

SYSTEM OVERVIEW **Roto**i

Non-thermal break version

- The "dual channel" design enhances the flexibility and stability of hardware application
- Multi-chamber design improves the strength and the ability to insulate sound, heat, prevent rainwater, and allows special hardware solution to improve the performance
- Sloped frame surface and clip-on outer track made the water drain out easier and faster
- Option on threshold with high tightness or easy access

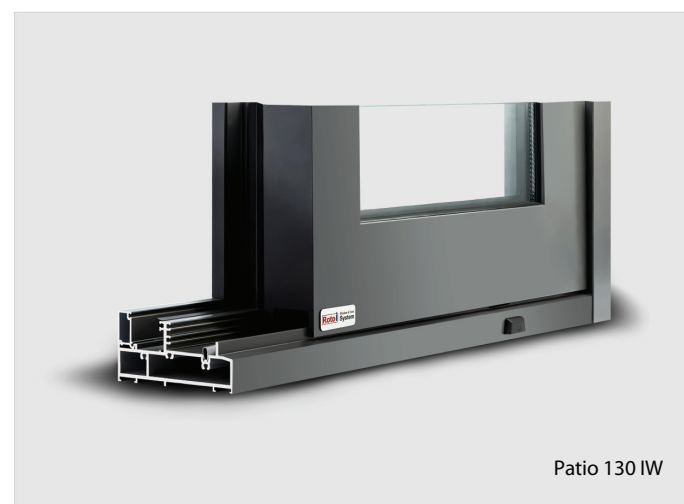
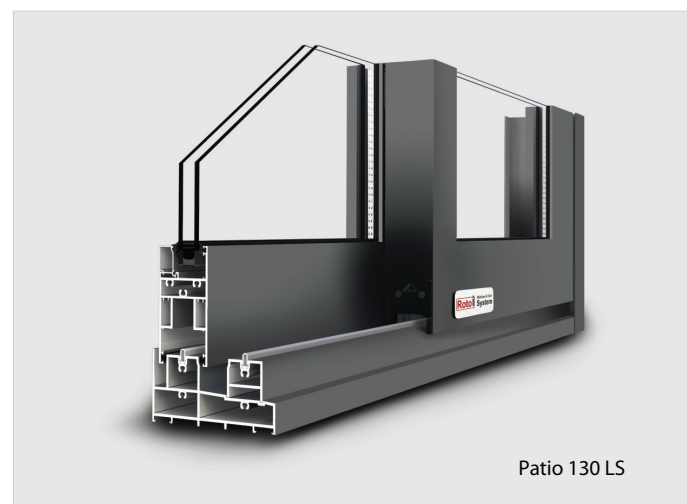

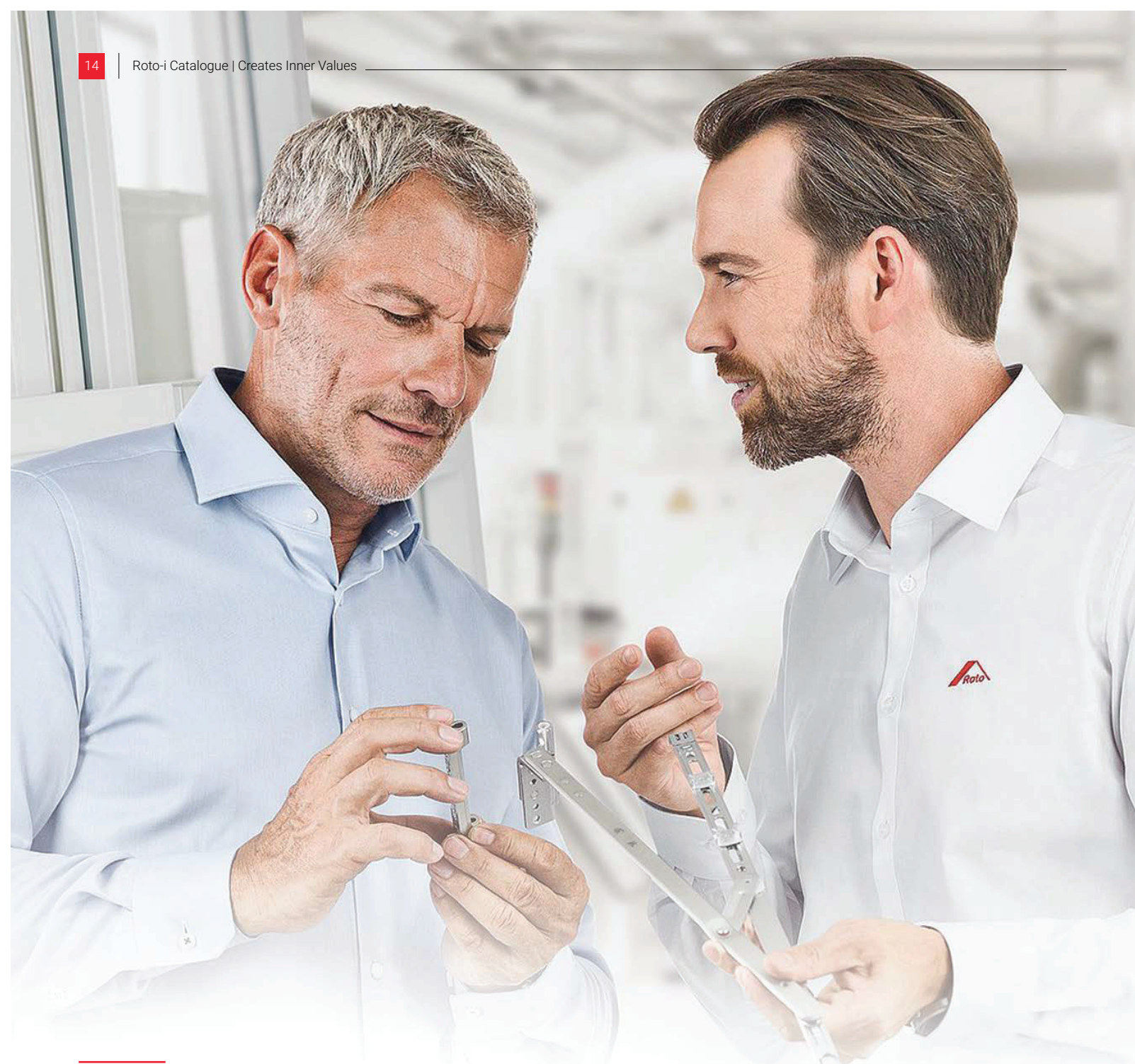

ROTO ITC

International Technology Centre

- The Roto International Technology Centre, an in-house test center, is located on the grounds of the headquarters of Roto in Leinfelden, Germany. It is certified by DAKKS according to DIN EN ISO / IEC 17025 and is authorized to perform accredited testing of windows & doors and its accessories.
- The test center, equipped with the most advanced testing equipment, although located at the Roto site, is an autonomous facility to enable objective testing
- The Rotoi system profits from the full access to the test center together with the support of the R & D team. Different combinations of profile, glass, accessories and hardware have been tested and analysed over to accumulate a large amount of data which enables us to identify the optimal combinations for the system.
- Spot tests of finished Rotoi products are a standard of the strict Roto testing procedure to assure constant quality.

CERTIFICATES

*Certified Lab Roto ITC

*10 years functional warranty

*ISO14001

*PSB Test Report for Roto-i system

*Singapore Green Building

*IFT certificate for hardware system

**HIGH-FUNCTIONING
WINDOW AND DOOR
SYSTEM**

**LARGE SLIDING DOOR
SYSTEM
ROTO PATIO**



Setting new standard for the operation of large doors



Bringing nature into interior design



Bringing the optimal experience of living space to customers

ROTO PATIO INOWA 130 IW

Intelligent hardware for tightly sealed sliding system

Rotoi Patio 130 IW is setting new standards for sliding openings when it comes to tightness and security, is therefore ideal for all kinds of building. The system guarantees to remain tightly sealed when facing challenges from extreme climate, especially in heavy storms. Rotoi Patio 130 IW satisfies sliding openings that need to meet high performance requirements, in term of tightness, sound reduction and security.



Mai. Characteristic:

- Convenient and simple operation which requires little force thanks to innovative closing movement perpendicular to the frame profile
- Sash weight up to 200 kg. Dimensions up to 2000 mm wide and 2500 mm high
- Tightly sealed thanks to circumferential gasket and active control of all locking points including in the mullion

Adva. tages:

- Protection against intrusive noise In city centre, near busy roads and airports
- Effective operation of air conditioning
- Lower cooling costs
- Comfortable house
- Peace and tranquility

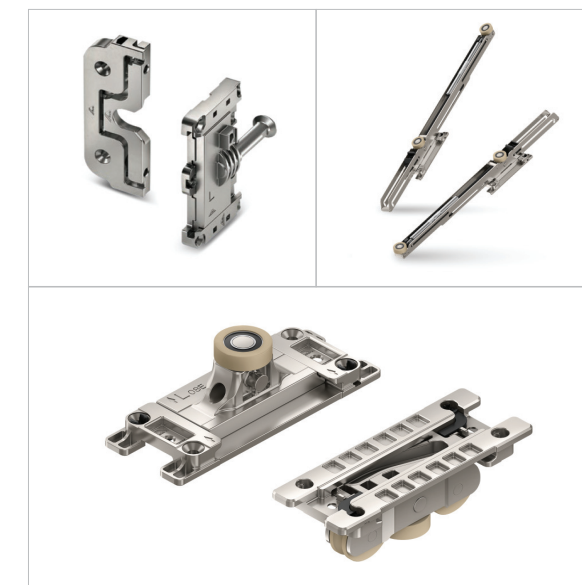

PROFILE PATIO 130 IW

Max sash height 2800mm
Max sash weight 200kg

The cover of the rain gutter to avoid insects

Rubber gaskets surround the wings, ensuring tightness

PA track is made from stainless steel, increasing the durability of hardwares and supporting the door to operate smoothly

Remains tightly sealed even in stormy weather

Patio 130 Sliding door brings light into living rooms or business premises, provide a smooth transition from indoor to outdoor areas and save space. The tightly sealed sliding system Patio 130, with the smart hardware Roto Patio Inowa, now ensures a high degree of comfort. No other provides a better seal!

A storm outside and a feel - good climate indoors at all times

Patio 130 with Roto Patio Inowa is setting new standards when it comes to window and door tightness and is therefore ideal for use in high-rise buildings where high wind loads occur. This system is guaranteed to remain tightly sealed even in thunderstorms where gusts of wind and torrential rain are hitting the glass and window frame directly. There is no trace of draughts or rattling sashes - thanks to this unique technology

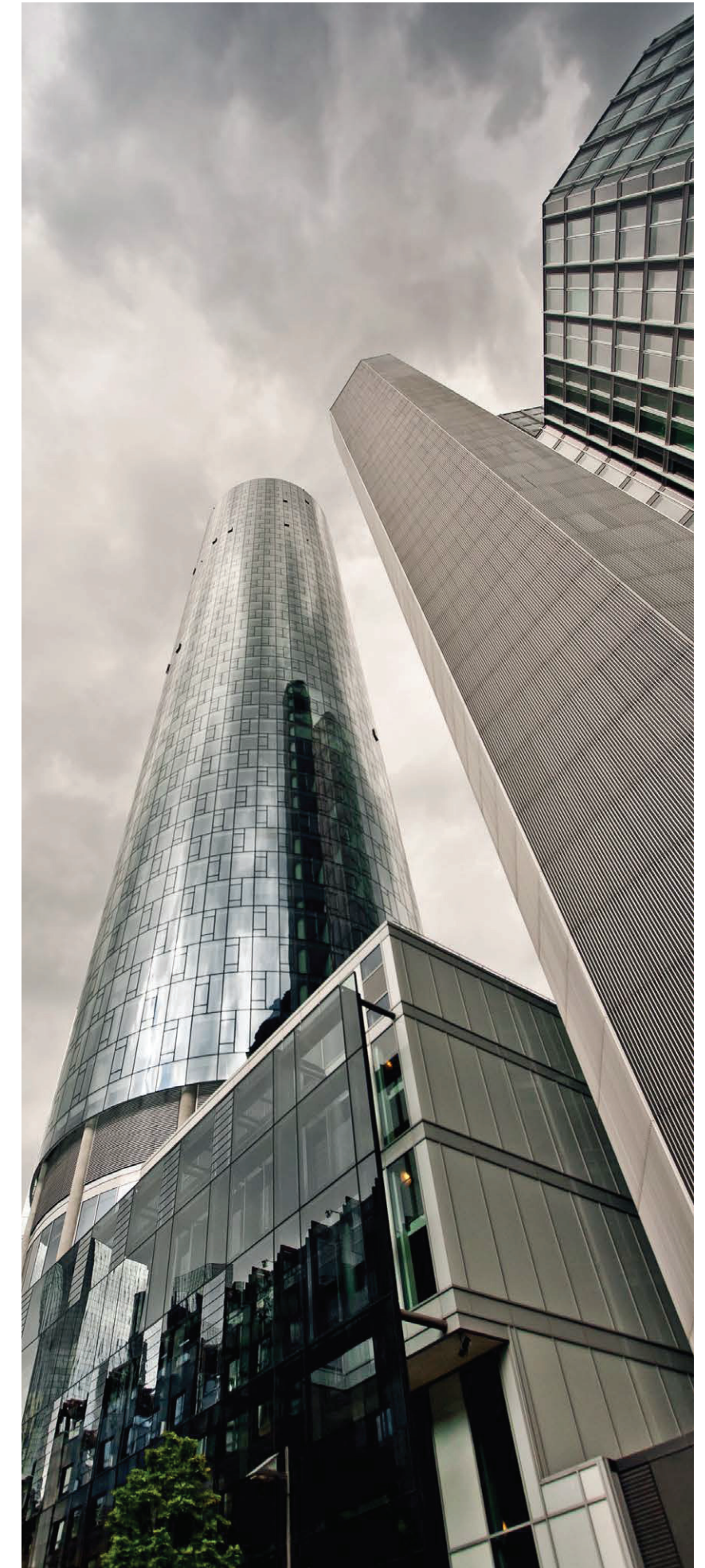

ROTO PATIO LIFT&SLIDE 130 LS

Smooth operation for panoramic sliding system

Roto Patio 130 LS(Lift&Sliding) brings great operating convenience and a sophisticated design to any modern building. The Slim variants unlock many additional possible applications: even modern, slimline profiles with minimal visible widths and high design standards. The proven system is easy to install and also impresses with its quiet operation and outstanding durability



Mai. Characteristic:

- Wide range of applications from 150kg to 400 kg sash weight
- Can also be used with modern Slim profiles
- High-quality, durable roller unit technology for quiet, convenient sliding
- Burglary inhibition in accordance with RC 2

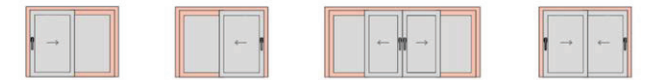

Adva. tages:

- Suitable for oversized doors designs
- Suitable for designing houses, offices, villas, duplex apartments, large space

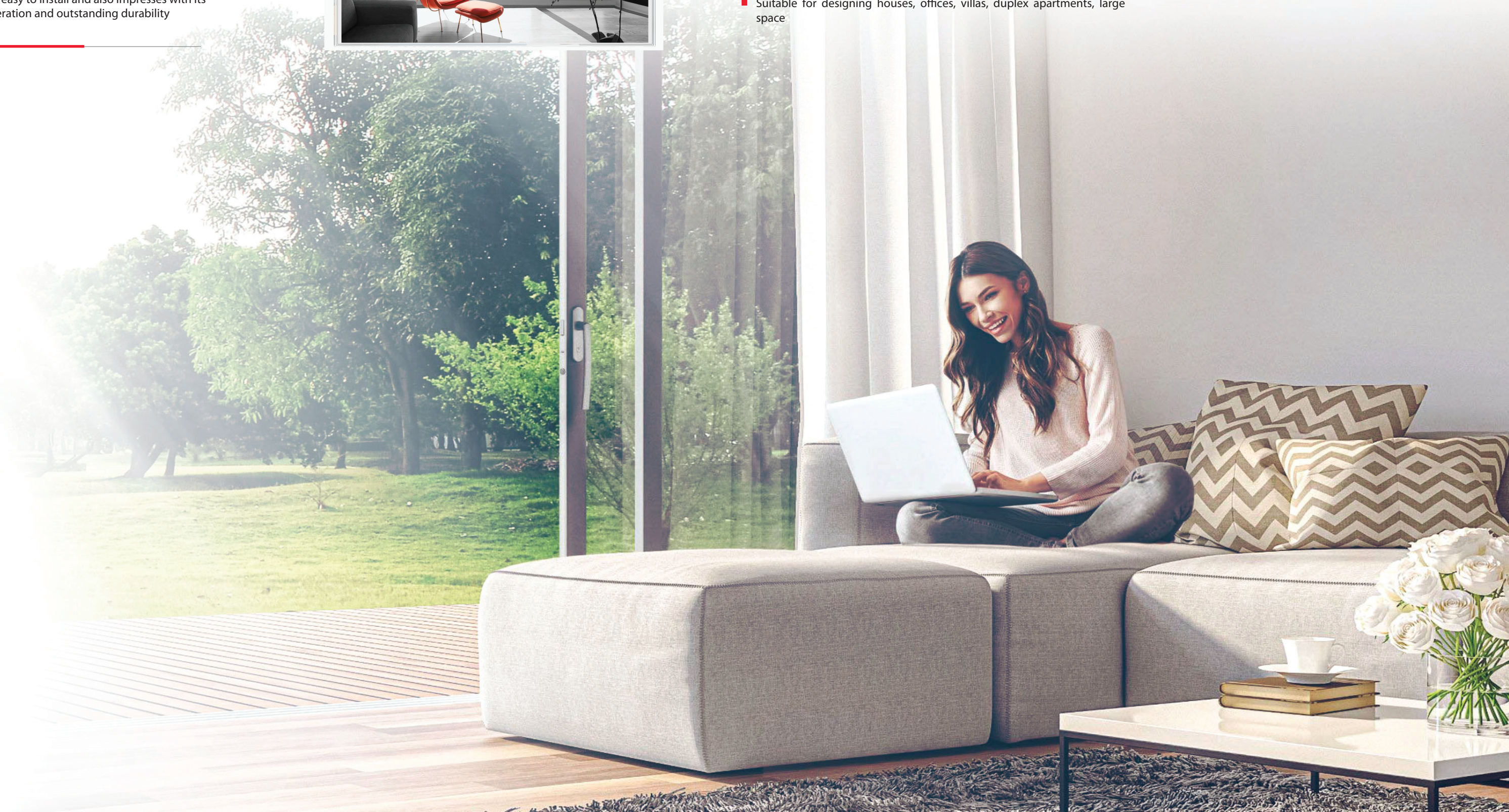

PROFILE FN52D

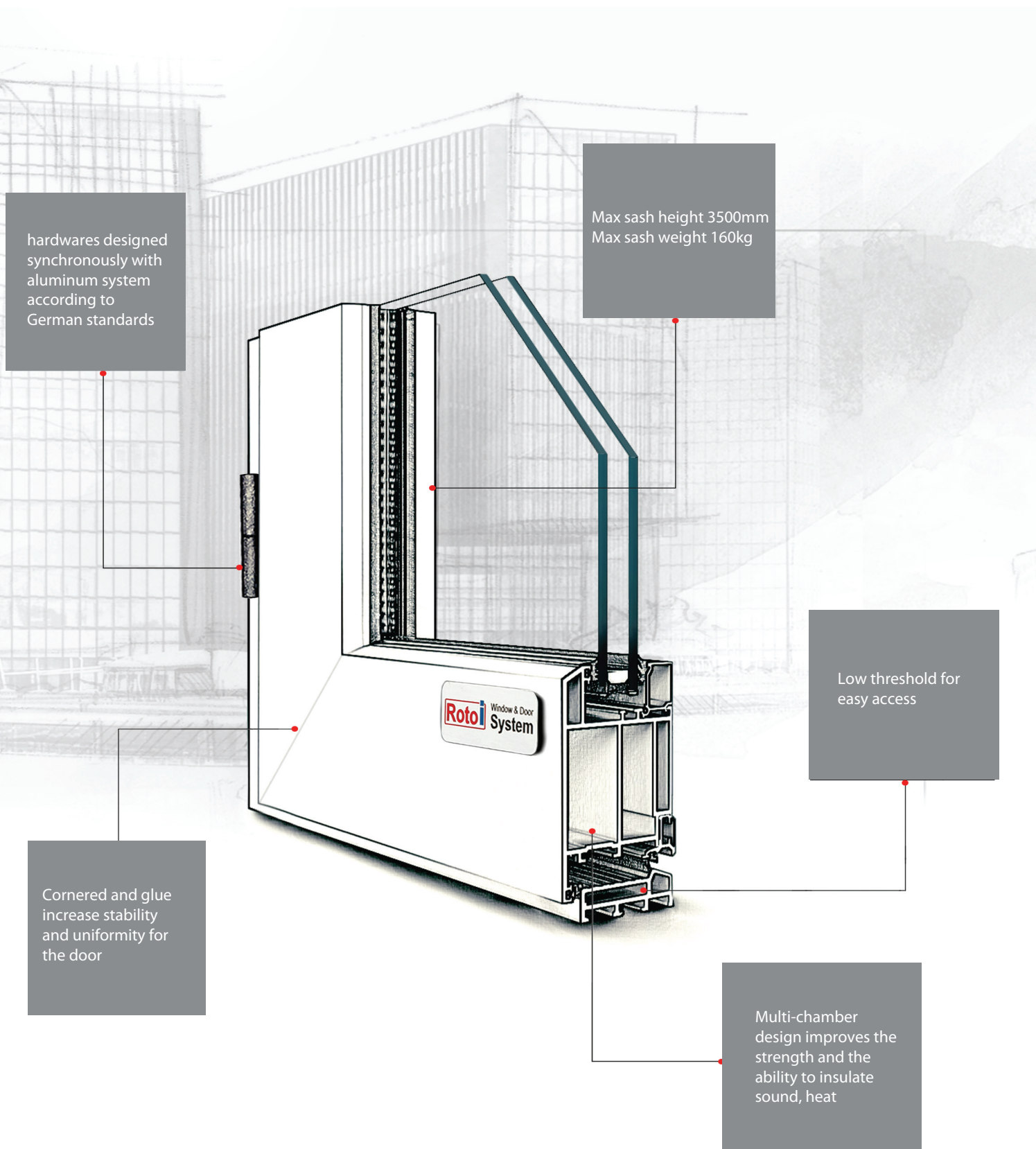

ROTO PATIO ALVERSA TILT&SLIDE FN52D

Ventilation and space saving



Patio Door System: Tilt&Slide, Parallel&Slide and Fold&Slide door can be made with the same profile range and different hardware solutions. It is also designed to meet the needs of residential and commercial buildings.

Mai. Characteristic:

- Modular sliding system: high proportion of common parts
- Universal central locking system and standard window handle
- Intuitive and comfortable operation as well as quiet running
- Burglary protection up to RC 2N (even with night ventilation)

Adva. tages:

- Suitable for spaces that need multi-functional doors with high applicability
- Simple and fast manufacturing thanks to compatible assemblies

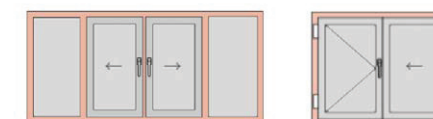

ROTO PATIO FOLD&SLIDE FN52D

Connecting spaces with panoramic view

Roto Patio Fold&Slide doors give you generous and-where needed- barrier-free access to terraces, conservatories, conference rooms, guest rooms or business rooms, besides being equally suited to use as room dividers. All door elements can be folded to save space and can be pushed to the side.

Mai. Characteristic:

- Optimised roller units on ball bearings, with quiet rollers made of PVC for more comfort and durability
- Maximum number of 8 wings (including main and folding wings)
- Technical data:
Sash width access sash: 480 – 1230 mm
Sash width folding sash: 480 – 930 mm
Sash height: 630 – 2830 mm
Sash weight: max. 100 kg
Frame external width: max. 6000 mm

Adva. tages:

- Full opening width gives a generous access
- Suitable for projects with garden villas, resort hotels, works with unique external landscapes
- Energy-efficient, barrier-free comfort threshold
- Connecting indoor space and outdoor landscape.

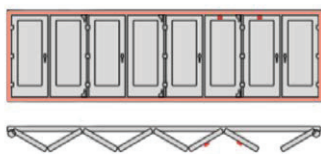
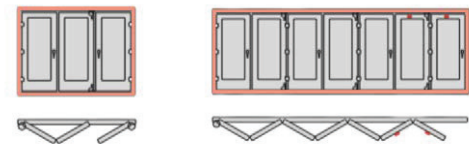
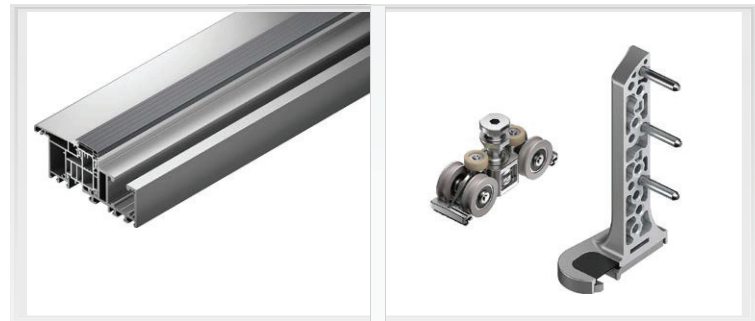

BASIC WINDOW AND DOOR SYSTEM



INWARD/OUTWARD OPENING DOOR FN52D



Inward/outward opening door are popular choice for residential and commercial buildings. This is a basic door system using MVD H650 multi-point locking system, Roto Safe E fingerprint lock.

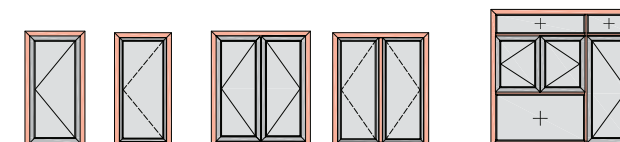

Mai. Characteristic:

- Dual angle clamps on the wing and frame increase the stability of the whole door
- Max sash weight 160kg
- Max sash height 3700mm
- Possibility to integrate master key or key alike

Adva. tages:

- Flexible combination of electronic systems, diverse uses
- Cost savings

SLIDING DOOR PATIO 130 SW



Patio 130 SW system is developed towards the needs in Asian market, that give consideration to strength, tightness, reliability and cost efficiency at the same time.

The hardware system from Roto improve the overall performance of sliding smoothly.

Mai. Characteristic:

- Window and door share the same frame
- Both 2 - track and 3 - track frame are available
- Crimped sash joint improves the sash stability and the frame could be assembled at site for easy transportation.
- Sloped frame surface and clip-on outer track made the water drain out easier and faster
- Replaceable PA track gives smooth sash movement
- Exchangeable glazing bead allows glass from 5~20mm
- Compatible with most fly screen solutions at room side or outside



TILT&TURN INWARD OPENING WINDOW FN52T

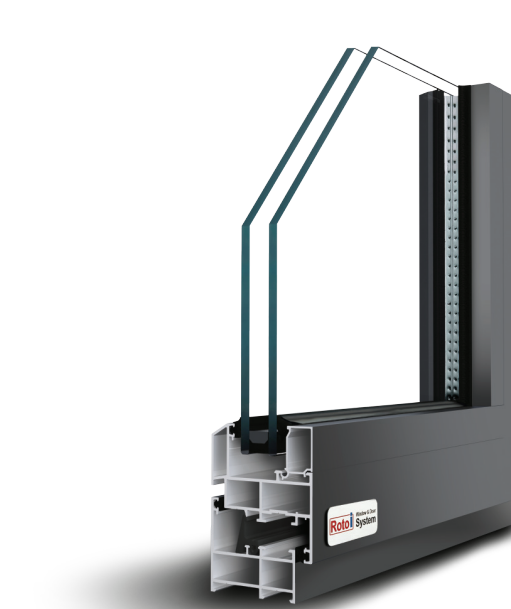

FN52T window system is developed to allow the typical European inward opening window to cope with the extreme climate in Asia-Pacific region.

Equipped with the most reliable hardware from Roto, the inventor of Tilt & Turn, it embody the descent of German window technology and bring the comfort to the end - users

Mai. Characteristic:

- Flushed frame and sash on outside surface
- Multi - chamber structure of main profiles and close - chamber glazing bead
- Dual corner joint on both sash and frame enhance the stability of entire window
- European standard hardware groove
- Flexible glass option with thickness from 5 to 32mm

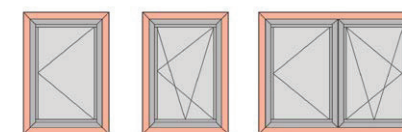

OUTWARD OPENING WINDOW FN52C



FN52C is designed to fulfill high performance requirement and to satisfy the visual requirements of slim frame.

It offers the possibility to complete the glazing work of entire window to at room side and keep the most possible slim sight surface.

The "dual channel" design enhances the flexibility and stability of hardware application

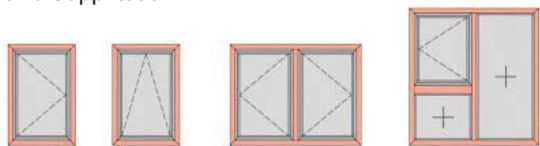

Mai. Characteristic:

- Multi - chamber structure of main profiles and closed - chamber glazing bead
- Dual corner joint on both sash and frame enhance the stability of entire window
- Hardware are positioned in designed grooves to ensure the security and stability in practice
- Flexible glass option with thickness from 5 to 34mm

ROTO X-DRIVE OP60



Mai. Characteristic:

- Includes locking system, hinge and moving handle
- Stainless steel locking system with 6-point triggering

Adva. tages:

- Suitable for designing garden houses, villas, resorts, hotels in the mountains
- Anti-insect and anti-dust trittec net can be installed

The window system using the X-drive handle has become familiar in the US. When coming to the Asian market, this window system has the advantage of installing an integrated anti-insect and anti-dust system; meet your needs in designing houses with lots of trees in tropical climates



WINDOW WALL WW150

Window Wall System: an innovative and high quality architectural systems that add to the strength, energy efficiency and longevity of the building envelope. It has a frame depth of 150mm and features a 15mm Technform thermal break bar to enhance thermal insulation performance with U-values of 2.5W/m2K.



Main Characteristics:

- Aesthetic
- Multi-chamber of main profiles
- Significantly cost reduction compare to curtain wall
- Safer way of installation
- Flexible glass option with thickness from 24~34 mm

SURFACE TREATMENT

Surface Treatment for profiles and hardware

Surface design of a connection element



- Optical seal
- Chromium VI-free passivation
- Corrosion protection system with microcrystalline structure
- Base material: steel

Roto Sil Level 6 stands out by virtue of being particularly tough and resistant to wear, therefore ensuring corrosion protection even in areas under extreme stress.



- Roto AVT coating
- Colour pigment layer
- Metallic base material

Tech. ology of profiles surface treatme. t:

- **Powder coating technology – PWD:** Choose from a variety of paint colors with a variety of surface finishes including glossy paint, textured paint, metallic paint... color warranty up to 25 years. Environmentally friendly paint material, free of lead and bleach, not release VOCs into the air, safe for users.
- **Anodisation technology:** creates a smooth surface coating that is resistant to UV rays and atmospheric corrosion, preserving the natural surface color of aluminum. Choose from modern colors such as bronze, silver, metallic gold, champaign, wood grain...

Roto hardware system is surface treated in a variety of ways, depending on the material of hardware, the position of hardware on the door and the function of hardware. Some examples of our surface treatment technology:

- **NanoSil6:** application for Roto NX line of accessories, for superior surface scratch resistance compared to other door accessories on the market. NanoSil is based on the most advanced Nano Technology available today, which not only meets the highest corrosion resistance standard DIN EN 1670 (Class 5), but also exceeds DIN EN 13126 - 8. Research shows that the products use this technology is surface treated Nanosil 6 of Roto technology has outstanding advantages in public works with high frequency of use, helping to save on periodic maintenance costs.
- **AVT coating:** application for the Roto Line handle, creating a safe layer of protection against viruses transmitted through the doorknob. This is the first antibacterial surface treatment technology on the market, suitable for constructions with strict standards of cleanliness such as hospitals and schools.



TYPICAL PROJECTS



Ecopark Hanoi



Da Nang city



Hai Duong City



Vinhome Gardenia Hanoi



Tay Ho, Hanoi



Trich Sai, Hanoi



Vinhome Riverside Hanoi



Diplomatic Corps villa area, Hanoi



Gamuda Hanoi



Starlake Villas, Hanoi



Ecopark Hanoi



Villa Ninh Binh City



Vinh city, Nghe An



Vinhomes Tan Cang, Ho Chi Minh City

INTERNATIONAL PROJECTS

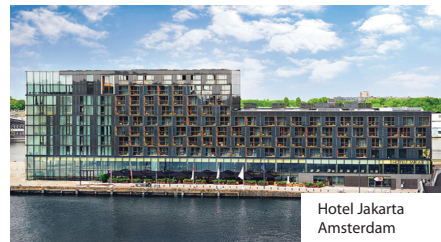

Roto*i* TEST RESULTS

FN52C	Method and Classification	Results	Static Pressure (Pa)
Air Tightness	ASTM E283/E283M-19	Air Infiltration: 0.20m³/hr/m	600
Water Tightness	ASTM E331-00 ASTM E547-00		1000 0~1400
Structural Performance	ASTM E330/E330M-14		3600
Proof Load	ASTM E330/E330M-14		5400

Patio 130 SW	Method and Classification	Results	Static Pressure (Pa)
Air Tightness	ASTM E283/E283M-19	Air Infiltration: 0.69m³/hr/m	300
Water Tightness	ASTM E331-00 ASTM E547-00		300 0~450
Structural Performance	ASTM E330/E330M-14		1200
Proof Load	ASTM E330/E330M-14		1800

Patio 130 LS	Method and Classification	Results	Static Pressure (Pa)
Air Tightness	ASTM E283/E283M-04	Passed	300
Water Tightness	ASTM E331-00 ASTM E547-00	Passed	500 0~1000
Structural Performance	AAMA TIR-11	Passed	1500
Proof Load	ASTM E330/E330M	Passed	2250

Patio 130 IW	Method and Classification	Result	Ref. Pressure (Pa)
Air Tightness	ASTM E283 - 04	Passed	600
Water Tightness	ASTM E331 - 00 ASTM E547 - 00	Passed	1000
Structure Performance	AAMA TIR - 11	Passed	2700
Proof Load	ASTM E 330/330M	Passed	4050

FN52D	Method and Classification	Result	Ref. Pressure (Pa)
Air Tightness	BS EN 1026 BS EN 12207	Class 4	600
Water Tightness	BS EN 1027 BS EN 12208	8A	450
Wind Load	BS EN 12211 BS EN 12210	B5	2000
Acoustic	ASTM E 90	STC 36	

WW150	Method and Classification	Result	Ref. Pressure (Pa)
Air Tightness	BS EN 1026 BS EN 12207	Class 4	600
Water Tightness	BS EN 1027 BS EN 12208	9A	600
Wind Load	BS EN 12211 BS EN 12210	B5	3000
Acoustic	ASTM E 90		



Air Tightness



Water Tightness



Wind Load



Acoustic

ROTO FRANK HOLDING AG

Global Headquarter

Wilhelm-Frank-Platz1
70771 Leinfelden-Echterdingen Germany
Tel: +49 711 7598 - 0
Fax: +49 711 7598 - 253
<https://www.ROTO-frank.com/de/>

SINGAPORE

Asia-Pacific Regional Headquarter

Roto Frank Asia-Pacific Pte. Ltd.
19 Joo Koon Road Singapore 628978
Tel: +65 6662 9240
Fax: +65 6795 3738
<https://ROTO-frank.com.sg>

VIETNAM

Vietnam Representative Office

C9 Mandarin Garden, Hoang Minh Giam,
Trung Hoa, Cau Giay, Hanoi
Hotline: 0983 500 860
Tel: +84 246 282 6500
Fax: +84 246 282 6501
<https://ROTO-frank.com.vn>



AUTHORIZED DISTRIBUTOR

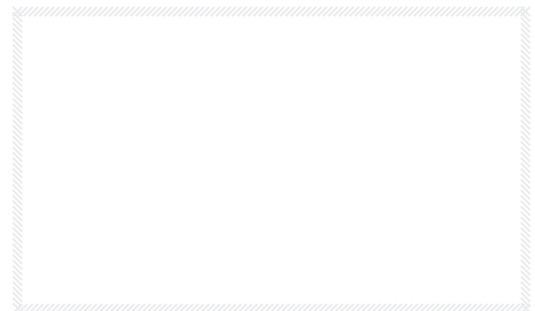

We reserve the right to change without prior notice.

©2021 Roto Frank Vietnam *Roto is a registered trademark